

# **ADEMCO PHOENIX™ 44 Laminator**

**Pouch / Roll Laminator**

## **Operators Manual Model ML44**



**REV C**

# TABLE OF CONTENTS

• OVERVIEW	3
• SAFETY INFORMATION	4
• SET-UP AND ELECTRICAL REQUIREMENTS	5
• STAND ASSEMBLY (OPTIONAL)	6
• ROLLER KIT INSTALLATION (OPTIONAL)	7
• ROLLER GAP CONTROL KNOB, REAR PANEL	8
• OPERATIONAL CONTROL PANEL	9
• MOUNTING USING A HEAT ACTIVATED MOUNTING BOARD	10
• MOUNTING AND LAMINATING USING A POUCH BOARD	11
• ENCAPSULATING USING A FLEXIBLE POUCH	12
• USING ROLL FILMS IN A PHOENIX	13
• CLEANING YOUR PHOENIX LAMINATOR	14
• TROUBLESHOOTING GUIDE	15
• TECHNICAL SERVICE / REPAIR CENTERS	16
• MOUNTING AND LAMINATING TERMS	17
• TECHNICAL SPECIFICATIONS	18
• WIRING DIAGRAM	19
• PARTS LIST	20
• LIMITED WARRANTY	23
PHOENIX SUPPLIES	24

# Owner's Manual Overview

Thank you for purchasing a PHOENIX laminator. We have designed the PHOENIX Laminator to give you years of reliable service. As you become familiar with the PHOENIX laminator, you will appreciate the high quality of its production and the excellence in its engineering design.

By following the guidelines for proper care and use of the PHOENIX laminator, you can depend on many years of trouble-free profitability from your investment. The purpose of this manual is to outline materials and processes. This manual will show you how to use PHOENIX supplies with your laminator to create signs, displays, and flexible graphics with professional results.

The manual includes instructions of various laminating procedures, which are meant to give you comprehensive information needed for the efficient use of your laminator.

**Please read and fully understand the entire manual before proceeding to use your laminator.**



## **MOUNTING AND LAMINATING USE**

Your Phoenix Laminator has been designed to be used with pouch boards, thermal laminating films and flexible pouches. When using pouch boards and film pouches, you are able to laminate and encapsulate prints in one step. You may also use roll film products and the PHOENIX has been tested and laminates well with polyester based films with low temperature adhesives (I.e. adhesive which work below 200 degrees). For other materials, you will have to test those films to determine the best settings and applicability of those products.

**WARNING! This laminator is designed for mounting and laminating. Any use other than the intended may cause damage to the laminator or physical harm to the user.**

WARNING! Any unauthorized changes or modifications to this unit without our prior written approval will void the user's warranty and will transfer health and safety obligations to the user.

## **LIABILITY STATEMENT**

The details given in this manual are based on the most recent information available to us. They may be subject to change in the future. We retain the right to make changes to the construction or the design of our products without accepting any responsibility for modifying earlier versions.

CAUTION! Please pay attention to all passages marked this way. This information is vital to preventing user injury and/or damage to the unit. Failure to follow this information could void the user's warranties and transfer all safety obligations to the user.

# SAFETY INFORMATION

When using electrical appliances, basic precautions should always be taken to reduce the risk of electrical shock and injury to persons, including the following:

1. Read all instructions before connecting or operating this unit.
2. Retain this Owners Manual for future reference. For technical assistance beyond what is covered in this manual contact Technical Service.
3. Save your carton! PHOENIX laminators are shipped in special cartons and should be used in case your PHOENIX laminator should ever require service or need to be transported.

**NOTICE! Failure to return machines properly packed in original packaging will impose a fifteen percent restocking fee plus costs to repair shipping damage. Contact Technical Service for a return authorization (see WARRANTY AND AUTHORIZED REPAIR CENTERS).**

4. Do not use the laminator for other than its intended use.
5. The Laminator case may be cleaned with a lint-free cloth, lightly dampened with a mild soap and water solution. Do not use spray-on cleaners.

**NOTE: Disconnect the laminator from the main power supply before cleaning!**

6. Do not immerse any part of the laminator in water or other liquids..
7. The laminator's location or position should not interfere with its proper ventilation. Do not install or place in a built-in enclosure such as a bookcase.
8. Do not operate the laminator with a damaged cord or plug, or after the laminator has been dropped or damaged in any manner. If purchased in U.S./Canada, return the laminator to your ADEMCO reseller for examination, repair or adjustment.
8. Do not let the cord hang over the edge of a counter/bench or touch hot surfaces.
9. Always unplug the laminator when it is not in use for a long period.
10. This unit should only be connected to a power supply outlet of the voltage, amperage, and frequency marked on the rear panel. The laminator has a grounded plug (three prongs). To reduce the risk of electrical shock, this plug is intended to fit only a grounded outlet of the proper amperage, and in only one way.

**If the plug does not fit in the outlet, contact a qualified electrician.**

**WARNING! Do not modify the plug in any way.**



# SET-UP AND ELECTRICAL REQUIREMENTS

The PHOENIX 44 is a professional laminator designed for ease of use. The process speed and temperature have been preset to eliminate operator guesswork. The factory setting will facilitate good quality results using the Flexible Pouches and Pouch Boards using low temperature adhesives.

The PHOENIX 44 can handle Flexible Pouches and Pouch Boards up to 44 inches (1120mm) wide.

Please familiarize yourself with machine operation before installation, operating the Control Panel and the Nip Control Knob.

## Installation of your PHOENIX Laminator

Please read and fully understand the entire manual before proceeding to use your laminator.

Without the PHOENIX Stand, your PHOENIX laminator must be lifted and carried to the place where it will be used. This should be done by at least two people, one on each side. Grasp the machine 8-10 inches (20cm-25cm) from the side. It should only be placed on a sturdy, clean, flat, level surface able to support 150 lbs. (70kg). See Stand instructions.

Keep the area around your laminator clear with adequate space around it so you can feed, receive and trim mounted and/or laminated images.

## Unpacking your Laminator

1. Open the box, and lift the machine out (at least two persons necessary!). Grasp the machine 8"-10" (200mm-250mm) from either side, at the bottom metal parts. Be careful! The polyethylene bag is slippery!
2. Place the machine on the work area described above.
3. Remove the protective molded foam.
4. Remove the polyethylene bag.
5. Inspect the machine for any physical damage (if damage does exist, report this to the Freight Company on the BILL OF LADING. Contact Your Dealer to determine if a replacement machine should be shipped to you.

## NOTICE! Retain original packaging.

Failure to return machines properly packed in original packaging will impose a fifteen percent restocking fee plus costs to repair shipping damage. Contact Technical Service for Return Authorization (see rear cover).

## Setting up your Laminator

The PHOENIX laminator should be installed next to a power/main outlet. We do not recommend using an extension cord, but if needed, make sure the cord rating meets or exceeds the machine rating.

The plug and the outlet must be easily accessible. Please ensure that you plug your laminator into a grounded, three-prong outlet. Please ensure that the total load of the other items using the same circuit breaker do not exceed its breaking value.

The US versions of the PHOENIX machines are provided with a fixed power cable and NEMA 5-20 plug.

**Use 120Vac 20A grounded outlet only.**



← **110V 20 amp outlet**

## Using your PHOENIX 44

Plug the power cable into the grounded outlet with appropriate service as described above.

Turn on power with main power switch. Roller will turn continuously while power is on.

Depress the Heat switch and wait approximately 20 minutes for the unit to reach its operating temperature. Also turn the Speed on and set the Control Knob to zero so that the roll heats uniformly. When Ready LED indicator is constantly lit, the PHOENIX laminator is ready for use.

**CAUTION! Set the Control Knob to the "Open" position when not in use.**

**NOTE:** The laminator may emit vapors the first few times it is used. This is normal and will cease after several minutes of use.

# STAND ASSEMBLY AND SET-UP (OPTIONAL)

## Tools Required

- Philips head screwdriver
- 4mm Allen wrench
- 14mm wrench or adjustable wrench

## Stand Kit Contents (Figure 1)

- (2) Side frames
- (2) Cross straight supports
- (8) 14mm Phillips screws & nuts
- (4) 4mm Allen screws



Figure 1

## Assemble cross supports (Figure 2)

Attach the cross supports to the side frames. Position the nuts on the inside of the stand. Leave the bolts finger tight until all of the stand has been assembled in Figure 3. Then tighten all of the screws securely.



Figure 2

**Insure all of the bolts are tightened before attaching the stand to your Phoenix laminator.**



Figure 3

## Attach stand to Phoenix laminator

Place your Phoenix Laminator on a flat secure surface. Rotate the laminator gently onto the back panel (do not pinch the power cord). Having one person holding the laminator, remove the feet from the bottom of the laminator and attach the stand with the 4mm screws supplied. The angled side is the back. Tighten securely. Then with 2 people lift the Phoenix into position (Figure 4).



Figure 4

# ROLL KIT ASSEMBLY (OPTIONAL)

## Tools Required

- Philips head screwdriver
- 4mm Allen wrench
- 14mm wrench or adjustable wrench

## Roll Kit Contents

- (1) Dispensing Bar with tensioner
- (2) Dispensing bar Support brackets
- (1) Idler bar with 4mm allen screws

## IMPORTANT! - Unplug you laminator before installing the Phoenix Roll Kit

### Remove the side panels

Lower the rollers to the closed or zero position. Remove the roller gap control knob by taking off the center cover of the Control Knob and unscrewing the philips screw in the middle of the Control Knob (Figure 1) and side panels gently and angle from the back as the control panel will be attached to the circuit board on the side frame (Figure 2).

### Install Idler Bar (Figure 3)

Locate the pre-drilled holes in the sideframe in back of the rollers. Attach the idler roll threading the 4mm bolt through the hole in the side frame and tighten with the corresponding nut. Repeat on the other side.

### Install Roll holder (Figure 4)

Remove the upper back panel. Install roll holder brackets with the 3 phillips screws. Mount the roll holder in the bracket.

### Replace the side panels and Control Knob.

### Instructions for running cold films on Page 13

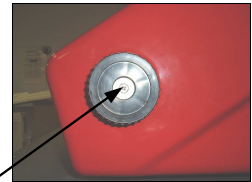

Figure 1



Figure 2

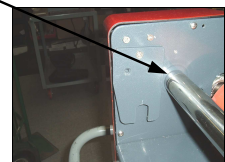

Figure 3

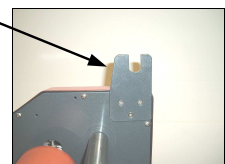

Figure 4

# ROLLER GAP CONTROL KNOB

The Control Knob (see figure 1A) is located on the right hand side of the laminator and should be operated from this side. The control knob is used to adjust the height of the rollers.

The Nip Settings are 1/4" (6mm), 3/16" (5mm), 1/8" (3mm) and 1/16" (1.5mm) correspond to Pouch Board thickness. There is also a closed position - 0" (0mm) for film and paperboard applications. Select the setting that indicates the thickness of the material you are using.

## To Operate the Nip Control Knob

1. Grasp it with your right hand and push in approximately 1/4" (6mm).
2. Once the knob has disengaged from the stop, it may be rotated forward or backward (clockwise or counterclockwise, as viewed from the right hand side of the unit).
3. Once the indicator has reached the desired nip setting, release the knob or gently pull the knob out to lock it in place. See Figure 1A.



Figure 1A

**Caution! Set the Nip Control Knob to the "Open" position when not in use.**

**Note: When the machine is warming up, set the control to the zero or closed position.**

# REAR PANEL

To turn the machine on and off, use the main breaker switch below in figure 1B.

"0" is off and "1" is on.



Figure 1B

Note: Always switch the power off when the machine is not in use. The Control Panel is always powered when the main power is on.

**In case of Emergency: Turn off the main power breaker or unplug the machine from the power outlet.**

**Caution! Turn off the main power breaker and unplug the machine when removing the side panels and performing maintenance on your Phoenix.**



# OPERATIONAL CONTROL PANEL

The Control Panel (see Figure 3) is located on the top right of the machine. A diagram of the Control Panel is shown in Figure 2.

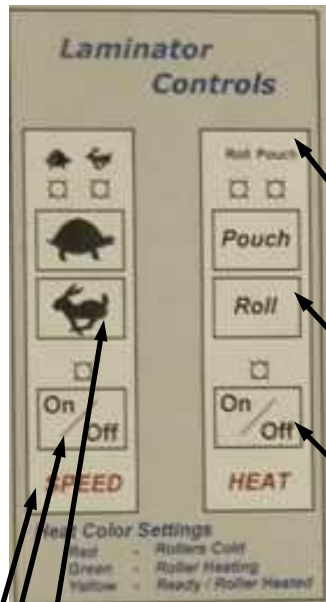

Figure 2

## Speed Control

The speed of the rollers is controlled in the SPEED section of the Control Panel.

1. **To turn the rollers on**, press the 'On/Off' pad once. The Green LED light will turn on indicating the bottom roller is turning. Note: the top roller is free spinning as with all high quality laminators. The PHOENIX will automatically be set to the faster 'Rabbit' speed.
2. **To adjust the speed of the rollers**, press the 'Rabbit' for the faster speed (approximately 1 foot per minute) or the 'Turtle' (approximately 6 inches per minute) for the slower speed. All standard pouches and pouch boards with inkjet paper up to 11 mils thick should work on the faster speed. For thicker materials, use the slow 'Turtle' speed. The LED light which is on is the current speed of the PHOENIX.



Figure 3  
Location of Control Panel

## Heat Control

The Heat of the rollers is controlled in the HEAT section of the Control Panel. When you turn the PHOENIX on, the heat will be off and the rollers cold. The LED Light above the 'On/Off' switch will be the color red.

1. **To turn the heat on**, press the 'On/Off' pad once. The LED above the 'On/Off' the PHOENIX will automatically be set to the 'Pouch' heat setting and the 'Pouch' LED will be lit. The LED above the 'On/Off' switch will be Green indicating the roller is heating. When that light becomes yellow, the PHOENIX is ready to process your pouch boards.
2. **To adjust the heat of the rollers**, press the 'Pouch' button when using pouch boards, mounting boards or flexible pouches. The 'Pouch' heat setting is the higher setting and has a roll face temperature of 150° Celsius. The Roll temperature is a lower 90° Celsius (195° Fahrenheit) for use with standard inkjet laminating films.

**In case of Emergency: Turn off the main power switch or unplug the machine from the power outlet. Open the Roller Gap Control to its fully open position and remove your work.**

# MOUNTING WITH HEAT ACTIVATED BOARDS

## Using a Heat Activated Mounting Board

Refer to the instruction sheet packed with each box of Mounting Boards for specific information on mounting with a heat activated Boards. All boards can not be thicker than 1/4" inch and must use low temperature adhesive.

Also, refer to the instruction sheet for information on Compatible Media, Process Conditions and technical information.

Place the image to be mounted on the adhesive-coated side of the mounting board (dull side of the board).

Cover your print with the "cover sheet" as marked (included with each box of Mounting Boards or use a sheet of non-stick silicon paper). If the release paper is longer, fold over the narrow end to make a 'pocket' for the board to be inserted into. Place your board with your print on it into the fold of the cover sheet.

**If you are overlaminating with roll film while using Phoenix mount boards, do not use any cover sheets but insure the laminating film is equal to or wider than your mount boards.**

Set the Roller Gap Control knob to the correct setting that matches the Mounting Board thickness.

Insert the board into the inlet opening. Ensure the board will enter centered and straight. A gentle push may be required to start the board into the laminator.

Hold the edges of the board until it is engaged in the unit and the laminator begins pulling it on its own.

The board will feed through the laminator and automatically exit at the rear of the unit.

**CAUTION! The board will be hot! Allow it to lie flat while cooling.**

CAUTION! USE ONLY WITH HEAT ACTIVATED MOUNTING BOARDS 1/4" (6mm) THICK OR LESS.

DO NOT USE PLYWOOD, METAL, CARDBOARD, SHARP OR HARD BOARD WITH RAGGED EDGES OR ANY TYPE OF PLASTIC.

MAKE SURE THAT ALL MEDIA FED INTO THE LAMINATOR IS FREE OF STAPLES, PAPER CLIPS, OR OTHER HARD OBJECTS.

Foam board may be cut or trimmed using a sharp hobby knife such as an X-ACTO Knife. Lightly score the paper first. Several passes of the knife may be required.

We recommend a professional grade trimmer with a standard utility knife blade be used for professional and fast results.

### NOTE:

Ragged cuts or pulling of the foam board indicates a dull blade.



# LAMINATING WITH POUCH BOARDS

Refer to the instruction sheet packed with each box of Pouch Boards for specific information on mounting/laminating with a Pouch Board.

In addition, refer to the instruction sheet for information on Compatible Media, Process Conditions and technical information.

Carefully examine the board to determine which edge is sealed. There is a 1/8" (3mm) sealed edge where the laminate film is attached to the board.

Starting at one of the corners, opposite the sealed edge, gently lift and peel back the film. Care should be taken not to break the sealed hinge.

Center the image to be laminated on the board and lay the film back over it.

Set the Control Knob to the correct setting that matches the Pouch Board thickness.

Ensure that the PHOENIX rollers are turned on and set either at the 'Rabbit' or 'Turtle' speed. With the Heat is on, set at the 'Pouch' setting and the LED light is Yellow indicating the roll temperature is ready to use.

**Note: If your laminate appears cloudy or your print is not fully adhered to the board, adjust the speed to the 'Turtle' setting and reprocess your pouch board.**



Slowly insert the Pouch Board into the inlet opening. Ensure that the Pouch Board will enter centered and straight. A gentle push may be required to start the board into the laminator.

Hold the edges of the Pouch Board until it is engaged and the laminator begins pulling it on its own.

The Pouch Board will feed through the laminator and automatically exit at the rear of the unit.

**CAUTION! The board will be hot! Allow it to lie flat while cooling.**

If there is any dirt or adhesive on the surface of the board, it can be removed by dampening a lint free cloth with Isopropyl Alcohol (IPA) and wiping the surface.

**CAUTION!** Always use care when using Isopropyl Alcohol (IPA)! IPA is very flammable. The flash point of IPA is 11°C (51.8°F). The self-ignition temperature is 400°F (752°F).



# ENCAPSULATING WITH FLEXIBLE FILM POUCHES

Refer to the instruction sheet packed with each box for specific information on encapsulating Flexible Film Pouches.

In addition, refer to the instruction sheet for information on Compatible Media, Process Conditions and technical information.

The Flexible Pouch consists of two pieces of film that are hinged at one end, along a short side. Separate the two pieces starting at the end opposite the hinge. Take care not to break the hinged seal.

1. Insert the article to be laminated in the pouch so there is at least a 1/8" (3.5mm) board around each of the sides. This ensures that moisture never reaches the image.

2. Place the pouch with the image on the sled included with the Flexible Pouches or Purchase Sleds separately.

**Note: The Sled is a non-stick board used to assist in the handling of large Flexible Pouches. It is made of materials that will not damage or cause excessive wear to your PHOENIX Laminator.**

3. Smooth out any wrinkles with the side of your hand or a soft flexible squeegee.

4. Tape the leading edge of the pouch to the sled using masking tape.



5. Adjust the Control Knob to the 3/16" (5mm) setting for the Sled included with your Dealers Flexible Pouches. (Or set the thickness to the thickness of the non-stick sled material you are using.)

6. Ensure that the PHOENIX rollers are turned on and set either at the 'Rabbit' or 'Turtle' speed. Turn the Heat is on, set at the 'Pouch' setting and wait for the LED light is Yellow indicating the roll temperature is ready to use.

**Note: If your laminate appears cloudy or your print is not fully adhered to the board, adjust the speed to the 'Turtle' setting and reprocess your pouch board.**

7. Slowly insert the sled with the Flexible Pouch on top into the inlet opening.

8. Ensure that the sled is centered and straight. A gentle push may be required to start the sled into the laminator.

9. Hold the edge of the sled until it is engaged, and the laminator begins pulling it on its own.

10. The sled should feed through the laminator and automatically exit at the rear of the laminator.

**CAUTION! The Sled will be hot! Allow it to lie flat and cool before removing the tape.**

If there is any dirt or adhesive on the surface of the board, it can be removed by dampening a lint free cloth with Isopropyl Alcohol (IPA) and wiping the surface.

**CAUTION!** Always use care when using Isopropyl Alcohol (IPA)! IPA is very flammable. The flash point of IPA is 11(51.8).The self-ignition temperature is 400(752).

# LAMINATING WITH ROLL FILM

Refer to the instruction sheet packed with each box for specific information on the roll film you are using. **We recommend using low temperature adhesives on either a 3 or 5 mil construction.**

The Phoenix is designed for roll films to laminate one side of a print, over-laminate a mounted print, or simultaneously mount and laminate using heat activated board.

If you are laminating one-side of a print, place your print on a sled or non-stick board. Phoenix sleds are all 3/16" thick. We recommend starting with the temperature to the 'Roll' setting and the Speed to the 'Rabbit' setting.

**If you are simultaneously mounting and laminating using a heat activated board, we recommend using boards which use a low temperature adhesive (i.e. below 160°F). Set the temperature to 'Pouch' and the speed to the 'Rabbit' setting.**

1. Set the Control Knob to the 3/16" thickness setting.
2. Mount you laminate roll on the top roll dispensing bar/supply mandrel. **Note: The Roll should be mounted on the Phoenix such that the film is being pulled from the bottom of the roll so that you are looking at the adhesive or dull sized of the film.**
3. Pull the film from the roll, place it behind the idler bar and drape the film over the top roller and roller nip opening (the adhesive on the film should begin to 'wet-out' or activate.
4. Using a Threading board (3/16" thick is supplied with the Phoenix Roll Kit), push the threading board into the nip of the rollers. Turn the Motor control on and select either the 'Rabbit' or 'Turtle' speeds. The threading board will be automatically pulled through the Phoenix with your roll film.

5. Inspect the film on the top roll of the Phoenix. It should be smooth and taught against the roll. If it is not, pull the threading board on the back of the Phoenix until the film smooths out. Once smooth, you are ready to laminate.

6. Ensure that the PHOENIX rollers are turned on and set either at the 'Rabbit' speed. With the Heat is on, set at the 'Roll' setting and the LED light is Yellow indicating the roll temperature is ready to use.

7. Set the Control Knob to match the thickness of the board you will be using.

8. Insert your board (either the sled with your print/mounted print/or heat activated board. with your print into the nip of the rollers. It will automatically be pulled through the laminator and over-laminated.

9. If laminating more than one print, insert it after the first print is done. Check the film on the roll face first. If it has some wrinkles, pull you first print unit they disappear and adjust the tension on the dispensing bar to maintain the film being smooth on the roll face.

10. Trim your print after it exits the Phoenix.

**Note: If your laminate appears cloudy or your print is not fully adhered to the board, adjust the speed to the 'Turtle' setting and reprocess your pouch board.**

**Caution: Do not trim near the rollers. Cuts and nicks in the roller can effect the quality of your laminating and require maintenance. Cuts and nicks in the roll face are not covered by the Warranty.**



# CLEANING YOUR PHOENIX LAMINATOR

## Cleaning the Outside of the Laminator:

**CAUTION! Disconnect the laminator from the power supply before cleaning.**

The laminator may be cleaned with a lint-free cloth, lightly dampened with a mild soap and water solution. Do not use a spray-on cleaner.

Do not immerse any part of the laminator in water or other liquid.

Do not use an abrasive cleaner, which can damage the painted surfaces.

Do not allow water or liquids to enter the electrical circuits, which may cause personal injury and/or damage the equipment when power is applied.



## Cleaning the Rollers

The laminating rollers of your PHOENIX should be periodically cleaned of adhesive build up that might occur during normal operation.

**IMPORTANT!** Clean the laminating rollers to prevent adhesive build-up and to ensure quality output. Adhesive build-up may eventually damage the rollers.

When laminating, a small amount of adhesive will squeeze out between the laminate films and onto the top and bottom rollers. This residue accumulates through normal use and can be easily cleaned off the rollers.

### **Use a Cleaning Board for regular cleaning:**

A new sheet of 3/16" foam board may be used to clean the rollers. Simply run the new board through the machine to remove any built up adhesive.

1. Turn on the unit. Once the machine has reached process temperature set the Control Knob to 3/16" (5mm).

2. Slowly insert the Cleaning Board into the inlet opening. Ensure that the board enters centered and straight. A gentle push may be required to start the board into the machine. Hold the edges of the board until it is engaged in the unit and the laminator begins pulling it on its own.

3. The board will feed through the laminator and automatically exit at the rear of the unit.

**CAUTION! THE BOARD WILL BE HOT!**  
**Allow the board to lie flat while cooling.**

**For heavier deposits of adhesive on the rollers,** turn your unit off and let it cool. Rub the rollers with Isopropyl alcohol and a Scotchbrite pad to remove the adhesive build-up.

# TROUBLE-SHOOTING / TECHNICAL SERVICE

PROBLEM	POSSIBLE CAUSE	SOLUTION
The Red LED Light above the rollers does not come on indicating the Main power switch is turned on.	The Power cord is not plugged in fully.	Check the Power cord.
	The main breaker is tripped.	Turn the breaker to the on.
	The circuit breaker is tripped.	Reset the circuit breaker.
Pouch Board is not being pulled into the PHOENIX or the motor is making a louder humming noise or is stalling. Only after pushing very hard is the board pulled into the PHOENIX.	The Pouch Board is too thick for the setting on the Roller gap control Knob.	Change the setting on the Roller gap control to the next thicker setting.
	The set screw on the roller gear may be loose	Contact Technical Service for instructions how to tighten set screw.
The Quality of the lamination is poor. There are silvery areas on dark surfaces which are visible or the edges of the image are not sealed well.	The roller temperature is too low.	Contact Technical Service for instructions on how to adjust temperature.
	The Speed is too fast.	If using the 'Rabbit' speed, try the 'Turtle' speed. Otherwise contact Technical Service for instructions on how to adjust speed.
	The Roller pressure is too low.	Adjust the setting on the Roller Gap Control to the next narrower setting.
The quality of the lamination shows bubbles or ripples.	The Roller temperature is too high.	Contact Technical Service for instructions on how to adjust temperature.
	The Speed is too slow.	If using the 'Turtle' speed, try the 'rabbit' speed. Otherwise contact Technical Service for instructions on how to adjust speed.
	There is too much pressure.	Adjust the setting on the Roller Gap Control to the next thicker setting.
There are wrinkles in either the flexible pouch or pouch board.	There is too much pressure.	Adjust the setting on the Roller Gap Control to the next thicker setting.
	The seal of the leading edge is not smooth.	Re-tape the entire leading edge smoothly

# SPARE PARTS / TECHNICAL SERVICE

## Technical Service

If the machine does not reach temperature or you do not get the results you desire, please contact your Technical Service Representative. When calling for Technical Service, please have the Laminator Serial Number available.

Please contact your distributor or sales person for replacement parts.

Your laminator is covered by a one-year Warranty as described in this manual.

## Servicing and replacement parts

Service and maintenance must be performed fully in accordance with the instructions. Servicing by any unauthorized technician voids the warranty. A service technician must use replacement parts specified by Technical Service.

NOTE! Service Technicians must perform safety checks after completing any service or repairs to the laminator.

# PHOENIX AUTHORIZED REPAIR CENTERS

## North East

Stover Graphics  
7A Railroad Avenue Ext.  
Beacon Falls, CT 06403  
203-729-2846

## Mid West

Film Source International  
13878 Parks Steed drive  
Earth City, MO 63045  
314-739-4400

## Mid Atlantic

Film Source International  
6601 S Laburum Avenue  
Richmond, VA 23231  
804.226.0400

## West Coast

Film Source International  
1487 North Main Street  
Orange, CA 92867  
800.831.8947

## South

Smooth Finish  
2385 Black Rock Drive  
Duluth, GA  
770.235.9374





# MOUNTING & LAMINATING TERMS

**Cleaning Board:**

Board used to capture any adhesive that may be clinging to the rollers.

**Cold Mode:**

Heat is off.

**Cover Sheet:**

Release paper to be placed on the surface of mounting boards.

**Roller Gap Control Knob:**

Adjusts the space between the rollers on the PHOENIX 44.

**Flashing Temperature Light:**

The machine has not reached temperature.

**Film:**

A synonym used for laminate. The material used in the laminating and encapsulating process.

**Flexible Pouch:**

Plastic Film Pouch for laminating paper.

**Heat-Activated Films:**

Films with an adhesive activated when heat is applied. Once applied to an image, the adhesive forms a strong bond between the laminate and the image.

**Hot Mode:**

Heat is on.

**Laminator:**

A machine used to mount and laminate images.

**LED:**

Light Emitting Diode (light).

**Mounting Board:**

An adhesive coated board used for mounting images.

**Nip:**

The spot where the top and bottom rollers meet.

**Out-Feed:**

The back of the laminator where completed images emerge.

**Pouch Board:**

An adhesive coated board with an over-laminate attached.

**Pre-Coating:**

The process of coating a substrate with an adhesive mounting film onto which an image can be mounted.

**Pressure-Sensitive Films:**

Films with an adhesive that is activated when pressure is applied, forming a bond between the protective laminate and the surface of the image. Used primarily for fast mounting applications and recommended for heat-sensitive thermal and photographic prints.

**Release Liner:**

The backing on a pressure-sensitive film or mounting adhesive used to keep the film from sticking to itself. After peeling the release liner off, the adhesive layer becomes exposed.

**Roller Height:**

The space between the rollers.

**Sled:**

A 3/16" (5mm) non-stick board used to place flexible pouches to aide the laminating process.

# PHOENIX SPECIFICATIONS

## Dimensions

Height	15.25"
Width	17"
Length	56"
Roll Dimension	4"
Net Weight	145 pounds
Shipping weight	200 pounds

## Operating Standards

Minimum Speed	6"/minute
Maximum Speed	12"/minute
Minimum temperature	195° Fahrenheit
Maximum temperature	300° Fahrenheit
Roll Core size	3" Inside Dimension (ID)
Maximum Roll size	6" Diameter
Roller Gap/Nip Settings	0 Closed (Rolls touch) 1/16" 1/8" 3/16" 1/4"
Stand Height	30"

## Electrics

U.S. Version	110V/60Hz 17A
U.S. Plug Configuration	AC Plug 3-Wire NEMA 5-20 Male
International	220V/50Hz 11A

## **Item Number**

ML44

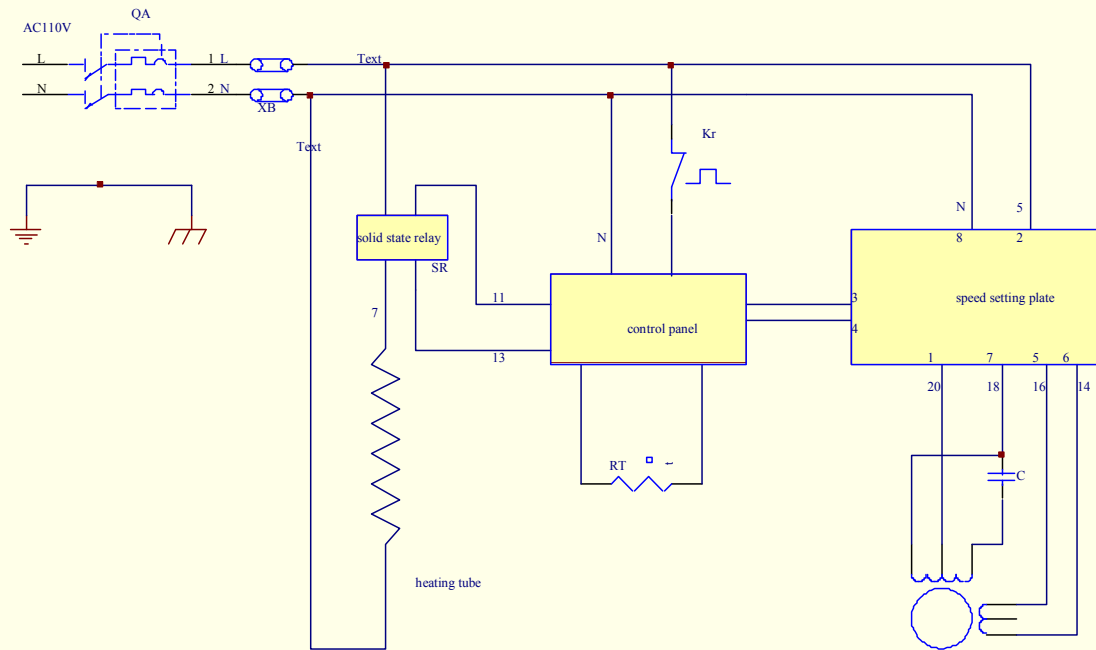

- 9 Temp.switch 150 degree, closed normally
- 8 speed setting plate
- 7 control panel
- 6 heating tube 115V/2000W
- 5 M motor YN80-25/110V speed rate 1:500
- 4 RT heat-sensitized resistance PT1000
- 3SR solid state relay 280V/50A
- 2 XB junction 2P 20A
- 1Q A switch DZ47-32 25A

Title		<b>Phenix wiring diagram</b>	
Size	Number	Revision	
A4	Ademco	图	
Date:	21-Mar-2008	Sheet of	图
File:	C:\Documents and Settings\yg\ \原理	Drawn By:	DDB 图

图 ( 英文板 )

# PHOENIX Laminator Parts Identification

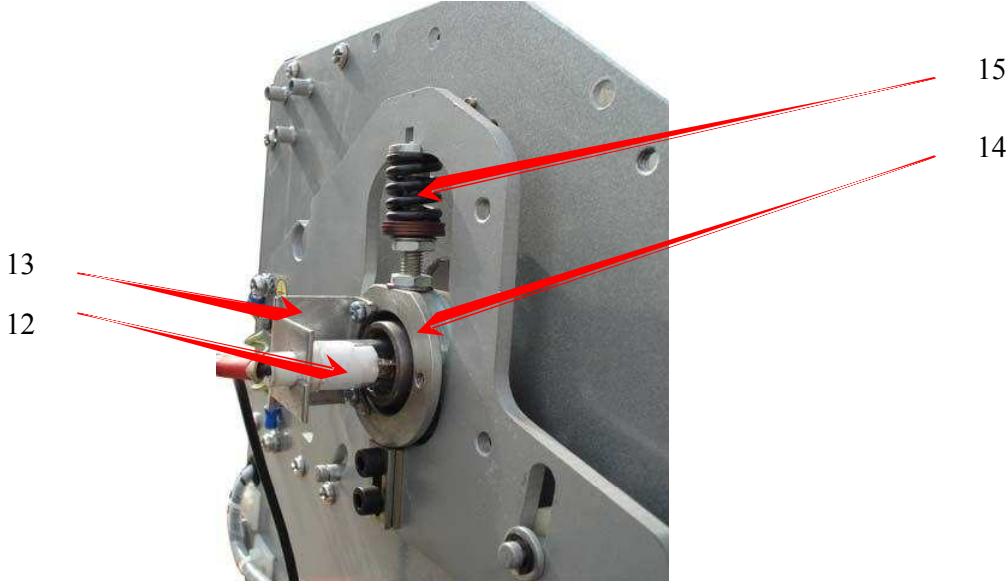
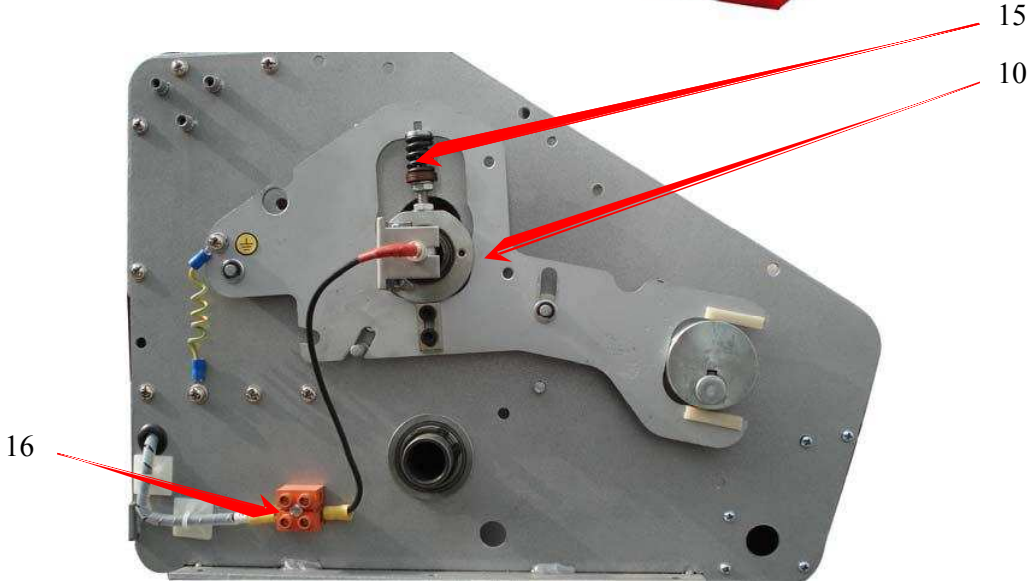

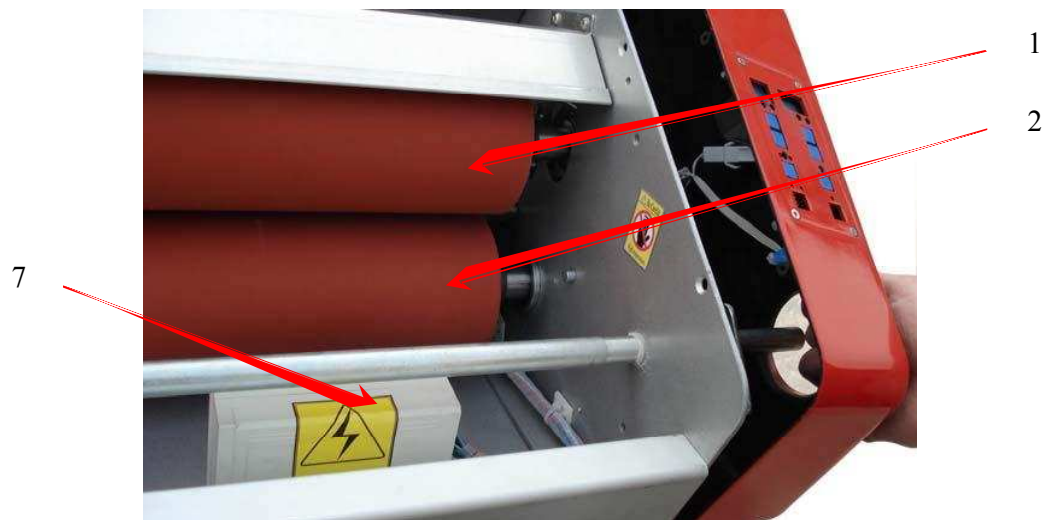
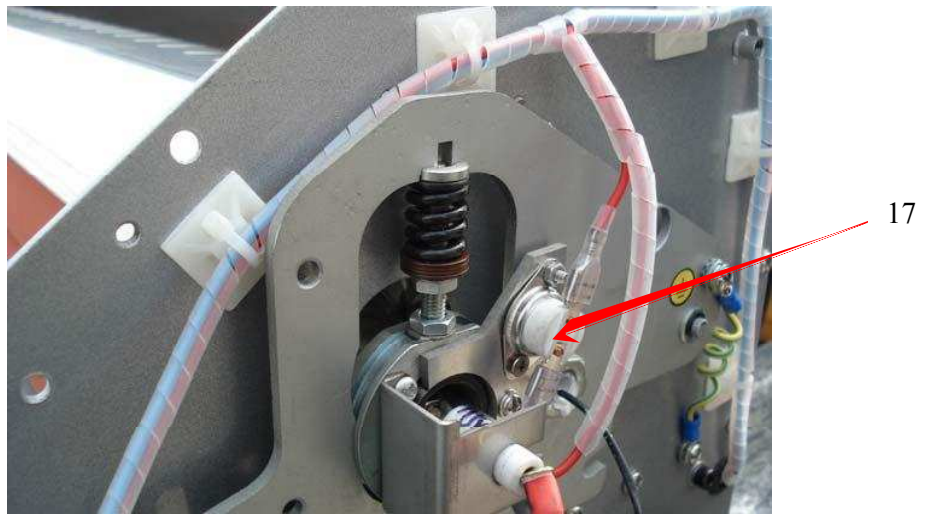
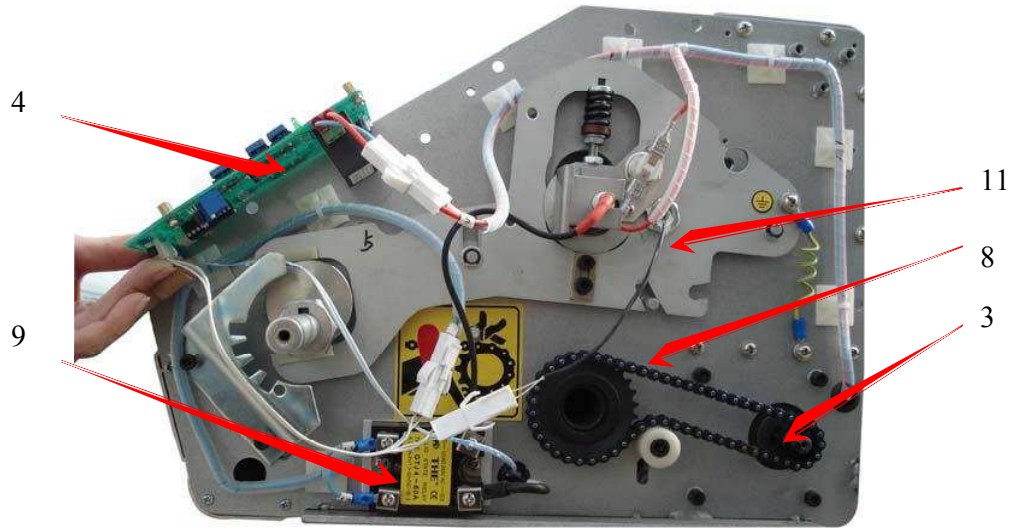



25

### ***PHOENIX LAMINATOR PARTS IDENTIFICATION***

<b>Part No.</b>	<b>Description</b>
1	Roller
2	Silicon Roller
3	Drive Motor
4	Mother Board
5	Front Table
6	Roller up-down Clamp
7	Speed Controller
8	Chain
9	SSR
10	Left Arm
11	Right Arm
12	Heating Tube
13	Stand for Heating Tube
14	Cover
15	Press Spring
16	Terminal Block
17	Overheating Protection
18	Supporting Roll for Film
19	End-Caps(Big)
20	Knob
21	Localizer
22	Left Frame
23	Right Frame
24	Heat-Shield
25	Contactor(Breaker)
26	Plank

# LIMITED WARRANTY

The Manufacturer warrants to the original consumer purchaser that each new PHOENIX Laminator which proves defective in materials or workmanship within the applicable warranty period will be repaired at our option or replaced without charge.

The Applicable Warranty period for the New PHOENIX Laminators shall be one year on parts and three months on labor and rollers from date of purchase.

After three months and for up to one year after the date of purchase, the manufacturer will complete Warranty repair labor at no charge provided the labor is completed at one of our Authorized Locations. It is the responsibility of the original consumer purchaser to return the PHOENIX laminator to our Authorized Locations. For a list of Authorized Repair Locations, please contact your Dealer.

All Warranty Repairs must be approved in advance by Technical Service. If returning the PHOENIX for approved Warranty repairs, it is the consumer's responsibility to insure the machine is packaged in its original packing to minimize the chances of any shipping damage. Shipping damage is not covered under this Warranty and is a matter between the consumer and the freight company used to transport this back to the authorized repair center. If you need proper packaging, your Dealer can supply such packaging at a nominal cost.

This Warranty extends to and is enforceable by only the original consumer purchaser, and only for the period (during the applicable term), which the product remains in the possession of the original consumer purchaser.

"Original consumer purchaser" means the person who first purchased the product covered by this warranty. It does not apply if it is found that at any time the equipment has not been used for its intended purpose.

Any unauthorized changes or modifications to this unit without our prior written approval will void the user's Warranty.

The applicable warranty period for Demo Equipment shall vary, not exceeding the maximum warranty period stated herein. All Demo Equipment comes with a specific warranty, which will be stated at the time of purchase. If warranty period is not detailed in writing, there is no remaining warranty. Please ask your dealer or sales representative for details.

Used Equipment or non-Demo equipment is sold on an "AS IS" basis with No Warranty. For more information regarding this warranty, please contact your distributor.

---

The information contained in this document is subject to change without notice.

The Manufacturer assumes no responsibility for any errors that may appear in the Owner's Manual. Nor does it make expressed or implied warranty of any kind with regard to this material including, but not limited to, the implied warranties of merchantability and fitness for a particular purpose.

The Manufacturer shall not be liable for incidental or consequential damages in connection with, or arising out of the furnishing, performance, or use of this document and the program material, which it describes.

# Phoenix Pouch Mounting Supplies

**We have the widest range of pouch boards to use on any pouch mounter-laminator.** The pouch boards listed on this page are our standard pouch boards. We can also make pouch boards from a variety of boards. We can also customize the adhesive to be compatible with the most medias. Whatever your customer's need, the chances are great that you can meet their needs with your pouch mounter-laminator. **When you have that special request, give us a call and we'll make those jobs fast and easy!**

**PHOENIX™ Pouch Boards** Available in 3/16" thick white or all black foam board. Choose from our low temperature adhesive boards or with one of our over-laminate films attached including: Gloss; Matte non-reflective finish with a slight texture which is scuff resistant; or Canvas. Mounting board cover sheets have exclusive insert folded edge. **No tape needed!** 10/box.



## White Foam Pouch Boards

<u>Size</u>	<u>Mounting</u>	<u>Gloss</u>	<u>Matte</u>
9" x 11.5"	(MB911WHT)	(C911WHT)	(M911WHT)
11.5"x17.5"	(MB1117WHT)	(C1117WHT)	(M1117WHT)
18.5" x 25"	(MB18WHT)	(C18WHT)	(M18WHT)
25" x 37"	(MB25WHT)	(C25WHT)	(M25WHT)
37" x 49"	(MB37WHT)	(C37WHT)	(M37WHT)
41" x 61"	(MB41WHT)	(C41WHT)	(M41WHT)

## Black Foam Pouch Boards

25" x 37"	(MB25BLK)	(C25BLK)	(M25BLK)
37" x 49"	(MB36BLK)	(C36BLK)	(M36BLK)
41" x 61"	(MB41BLK)	(C41BLK)	(M41BLK)



**Mount-a-Sign Thin Pouch Boards** 25 mil thick white paper board with low temperature heat activated adhesive available with or without gloss over-laminate film. Rigid enough to stand-up with an easel and can be used with all pouch laminators. Great for presentations for easy transport. 25/box.

<u>Size</u>	<u>Mounting</u>	<u>Gloss</u>
9" x 11.5"	(601182)	(601181)
11.5"x 17.5"	(601185)	(601184)
18.5"x 25"	(601187)	(601186)
25" x 37"	(601189)	(601188)

**PHOENIX Corrugated Plastic Pouch Boards** Pouch Boards made from 4mm thick white corrugated plastic coated with a heat activated adhesive and a gloss laminate for short-term signage. Flutes run vertically and the first dimension is the width of the board. (10/box)

12"x18"(CWPB1218)	18"x24"(CWPB1824)	24"x36"(CWPB2436)
18"x12"(CWPB1812)	24"x18"(CWPB2418)	36"x24"(CWPB3624)



# Mounting Supplies

## Wide Format Pouch Film Supplies



### PHOENIX Film Pouches

Film pouches for roll-up and flexible graphics including items such as blueprints, menus, maps, banners and other flexible graphics. Low temperature adhesive safe for use with inkjet media. A Sled is included with each box of 18"x24", 25"x37" and 36"x48" film pouches. Smooth Matte finish has a write-able surface and the matte laminate has a textured surface. 25 pouches/box.

<u>Size</u>	<u>Gloss</u>	<u>Gloss/Matte</u>	<u>Gloss/White</u>
9"x11.5"(50)	(601248)	—	—
12"x 18" (50)	(601247)	—	—
18.5"x24.5"	(606590)	(608513)	(606860)
25" x 37"	(606660)	(608517)	(606970)
36" x 48"	(606780)	(608519)	(607080)

## PHOENIX Roll Films

### Cold Mounting Adhesives (double-sided adhesive)

Choose from indoor lo-tack adhesive - good for most inkjet prints—or outdoor adhesives designed for heavier papers and hard to stick boards such as Gator or Sintra pvc. Both self-wound with a single silicon re-release liner. Rolls on 3" cores. Lo tack 25" and 51" rolls are 150' long.

<u>Type</u>	<u>25"x200'</u>	<u>38"x200'</u>	<u>41"x200'</u>	<u>51"x200'</u>
Lo Tack	\$119 (MES25150)	\$199 (MES38200)	\$229 (MES41200)	\$299 (MES51150)



### Gloss Thermal Over-Laminate Roll Films

High quality over-laminate films with low temperature adhesive (i.e. 185 - 200 degrees F, operating temperatures depend on running speed). Films are high grade optically clear polyester with UV absorbers for maximum protection against fading.

<u>Thickness</u>	<u>25"x200'</u>	<u>38"x200'</u>	<u>51"x200'</u>	<u>61"x200'</u>
3 mil	\$ 45 (IG25203)	\$ 62 (IG38203)	\$ 87 (IG51203)	\$ 95 (IG61203)
5 mil	\$ 69 (IG25205)	\$ 98 (IG38205)	\$120 (IG51205)	\$157 (IG61205)
10 mil	\$189 (IG25254)	\$248 (IG38254)	\$349 (IG51254)	—



### Inkjet Thermal Over-Laminate Roll Films

Laminating film featuring Inkjet Adhesive Technology. Approved by Xerox and Canon for use on color prints with Fuser oils and glossy papers.

<u>Finish</u>	<u>25"x200'</u>	<u>38"x200'</u>	<u>41"x200'</u>	<u>51"x 200'</u>
Satin	\$165 (FGL25205)	\$228 (FGL38205)	\$248 (FGL41205)	\$299 (FGL51205)
Matte	\$165 (FGM25205)	\$228 (FGM38205)	\$248 (FGM41205)	\$299 (FGM51205)
Velvet	\$185 (FGV25207)	\$254 (FGV38207)	\$274 (FGV41207)	\$340 (FGV51207)
Gloss	\$179 (FGG25201)	\$218 (FGG38201)	\$230 (FGG41201)	\$290 (FGG51201)

